

Centre Scientifique et  
Technique du Bâtiment

84 avenue Jean Jaurès  
CHAMPS-SUR-MARNE  
F-77447 Marne-la-Vallée Cedex 2

Tél. : (33) 01 64 68 82 82

Fax : (33) 01 60 05 70 37

**European Technical  
Assessment**

**ETA-13/0437  
of 18/06/2018**

*English translation prepared by CSTB - Original version in French language*

**General Part**

Nom commercial  
*Trade name*

**SPIT MULTI-MAX**

Famille de produit  
*Product family*

**Cheville à scellement de type "à injection" avec tige d'ancrage diamètres M8, M10 et M12 pour fixation dans les maçonneries.**

***Bonded injection type anchor with anchor rod sizes M8, M10, M12 for use in masonry.***

Titulaire  
*Manufacturer*

**SPIT SAS  
Route de Lyon  
26500 Bourg-Les-Valence  
FRANCE**

Usine de fabrication  
*Manufacturing plant*

**Société SPIT  
Route de Lyon  
FR-26501 BOURG-LES-VALENCE**

Cette évaluation contient:  
*This Assessment contains*

15 pages incluant 12 annexes qui font partie intégrante de cette évaluation  
*15 pages including 12 annexes which form an integral part of this assessment*

Base de l'ETE  
*Basis of ETA*

**EAD 330076-00-604, Edition juin 2014  
*EAD 330076-00-604, Edition June 2014***

Cette évaluation remplace:  
*This Assessment replaces*

**ATE - 13/0437 délivrée le 31/05/2013  
*ETA- 13/0437 issued on 31/05/2013***

*Translations of this European Technical Assessment in other languages shall fully correspond to the original issued document and should be identified as such. Communication of this European Technical Assessment, including transmission by electronic means, shall be in full. However, partial reproduction may be made, with the written consent of the issuing Technical Assessment Body. Any partial reproduction has to be identified as such.*

## 1 Technical description of the product

The SPIT MULTI-MAX for masonry is a bonded anchor (injection type) with perforated sleeve or a system ID-ALL and a anchor rod made of galvanised steel or stainless steel which is placed into a drilled hole previously injected with a two components injection mortar using an applicator gun equipped with a special mixing nozzle. The anchor rod is inserted into the resin with a slow and slight twisting motion. The mortar cartridges are available in different sizes 410 ml to 280 ml. The hollow sleeve or the system ID-ALL are not used for the heavy masonry.

The illustration and the description of the product are given in Annex A1.

## 2 Specification of the intended use

The performances given in Section 3 are only valid if the anchor is used in compliance with the specifications and conditions given in Annexes B.

The provisions made in this European Technical Assessment are based on an assumed working life of the anchor of 50 years. The indications given on the working life cannot be interpreted as a guarantee given by the producer, but are to be regarded only as a means for choosing the right products in relation to the expected economically reasonable working life of the works.

## 3 Performance of the product

### 3.1 Mechanical resistance and stability (BWR 1)

Essential characteristic	Performance
Characteristic tension resistance and shear resistance	See Annex C1
Displacements	See Annex C2

### 3.2 Safety in case of fire (BWR 2)

Not relevant.

### 3.3 Hygiene, health and the environment (BWR 3)

Regarding dangerous substances contained in this European Technical Assessment, there may be requirements applicable to the products falling within its scope (e.g. transposed European legislation and national laws, regulations and administrative provisions). In order to meet the provisions of the Construction Products Regulation (EU) n° 305/2011, these requirements need also to be complied with, when and where they apply.

### 3.4 Safety in use (BWR 4)

For Basic Requirement Safety in Use the same criteria are valid as for Basic Requirement Mechanical Resistance and Stability.

### 3.5 Protection against noise (BWR 5)

Not relevant.

### 3.6 Energy economy and heat retention (BWR 6)

Not relevant.

### 3.7 Sustainable use of natural resources (BWR 7)

For the sustainable use of natural resources no performance was determined for this product.

### 3.8 General aspects relating to fitness for use

Durability and Serviceability are only ensured if the specifications of intended use according to Annex B1 are kept.

## 4 Assessment and Verification of Constancy of Performance (AVCP)

According to the Decision 96/582/EC of the European Commission<sup>1</sup>, as amended, the system of assessment and verification of constancy of performance (see Annex V to Regulation (EU) No 305/2011) given in the following table apply.

Product	Intended use	Level or class	System
Metal anchors for use in masonry	For fixing and/or supporting to structural elements or heavy in masonry	—	1

## 5 Technical details necessary for the implementation of the AVCP system

Technical details necessary for the implementation of the Assessment and verification of constancy of performance (AVCP) system are laid down in the control plan deposited at Centre Scientifique et Technique du Bâtiment.

The manufacturer shall, on the basis of a contract, involve a notified body approved in the field of anchors for issuing the certificate of conformity CE based on the control plan.

Issued in Marne La Vallée on **18/06/2018** by  
Charles Baloche  
Directeur technique

*The original French version is signed*

1

Product in use:

Figure A1: Perforated sleeve in hollow masonry

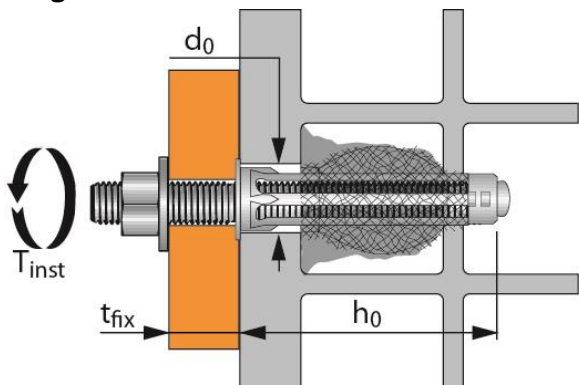
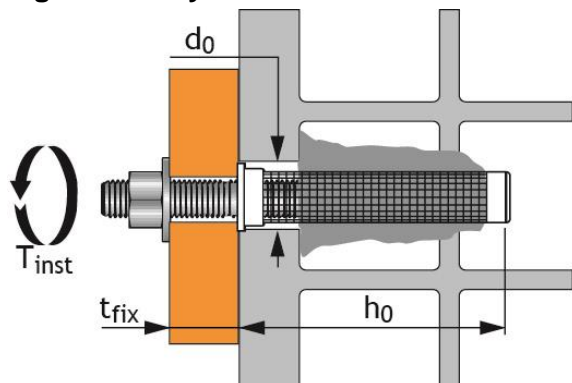

Figure A2 : System ID-ALL in hollow masonry



SPIT MULTI-MAX

System Description

Annex A1

### Injection system mortar MULTI-MAX

Cartridge 380 ml and 410 ml

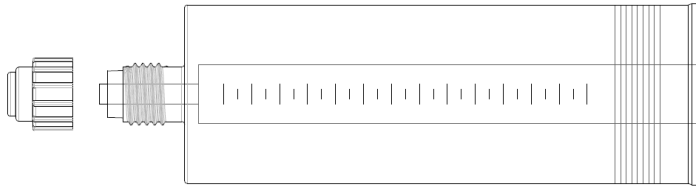

Cartridge 280 ml and 300 ml

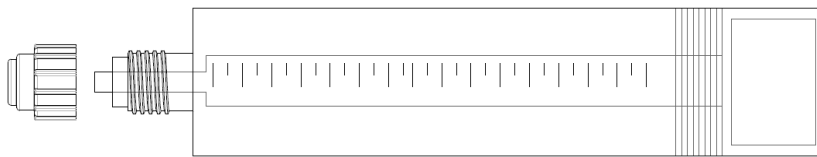

### Mixing nozzles



### Perforated sleeve



### System iD – ALL



Standard commercial threaded rod with identification marking sealing length



SPIT MULTI-MAX

Resin, mixing tip, anchors

Annex A2

**Table A1: Materials**

Designation	Material
<b>Injection mortar</b>	Methacrylate resin, hardener and inorganic agents
<b>Elements made of zinc coated steel</b>	
Threaded rod M8 – M12 (standard commercial rods)	Strength class 5.8,6.8, 8.8, 10.9 EN ISO 898-1, Zinc coating $\geq 5\mu\text{m}$ NF E25-009,
Washer	Steel DIN 513 Zinc coating $\geq 5\mu\text{m}$ NF E25-009,
Nut	Steel, EN 20898-2 Grade 6 or 8 Zinc coating $\geq 5\mu\text{m}$ NF E25-009,
<b>Elements made of stainless steel A4</b>	
Threaded rod M8 – M12	Stainless steel A4-70: 1.4401; 1.4404; 1.4578; 1.4571; 1.4439; 1.4362 acc. EN 10088
Washer	Stainless steel A4-70: 1.4401; 1.4404; 1.4578; 1.4571; 1.4439; 1.4362 EN 10088
Nut	Strength class 80 EN ISO 3506-2 Stainless steel 1.4401; 1.4404; 1.4578; 1.4571; 1.4439; 1.4362 acc. EN 10088
<b>Elements made of high corrosion resistant stainless steel</b>	
Threaded rod M8 – M12	Stainless steel HCR $R_m \geq 650$ MPa Acc. EN 10088, 1.4529 / 1.4565
Washer	Stainless steel HCR Acc. EN 10088, 1.4529 / 1.4565
Nut	Stainless steel HCR $R_m \geq 650$ MPa Acc. EN 10088, 1.4529 / 1.4565

SPIT MULTI-MAX

Annex A3

Materials

**Intended use**

**Base materials:**

- Solid masonry, hollow or perforated use category b and c;
- For the others solid masonry, hollow or perforated, characteristics resistances can be determined with field tests according to EOTA TR 054 with coefficient  $\beta$  given in the table C1 annex C3.

**Table B1: Overview use categories and performance categories**

Anchor		MULTIMAX	
Drilling		Hammer drilling	
Static and quasi static loading, in solid masonry, hollow or perforated		M8 to M12 Tables C1, C2, C3.	
Use category:		category w/w dry or wet (flooded holes are excluded)	
Installation temperature		0°C à 40°C (table B4)	
In-service temperature	Temperature range	-40°C to +40°C	(max long term temperature +24°C and max short term temperature +40°C)

**Use conditions (Environmental conditions):**

- Structures subject to dry internal conditions (zinc coated steel, stainless steel or high corrosion resistant steel).
- Structures subject to permanently damp internal condition :
  - if no particular aggressive conditions exist (stainless steel or high corrosion resistant steel).
  - with particular aggressive conditions (high corrosion resistant steel).
- Structures subject to external atmospheric exposure including industrial and marine environment :
  - if no particular aggressive conditions exist (stainless steel or high corrosion resistant steel).
  - with particular aggressive conditions (high corrosion resistant steel).

*Note: Particular aggressive conditions are e.g. permanent, alternating immersion in seawater or the splash zone of seawater, chloride atmosphere of indoor swimming pools or atmosphere with extreme chemical pollution (e.g. in desulphurization plants or road tunnels where de-icing materials are used).*

- Overhead installations are permitted

**Design:**

- Anchorages are designed under the responsibility of an engineer experienced in anchorages.
- Verifiable calculation notes and drawings are prepared taking account of the forces to be transmitted. The position of the anchor is indicated on the design drawings (e. g. position of the anchor relative to supports, etc.).
- The anchor is to be used only for anchorages subject to static or quasi-static loading in solid masonry (use category b) or in hollow or perforated masonry (use category c) according to annex B2. The mortar strength class of the masonry has to be M 2,5 according to EN 998-2:2010 at minimum

**SPIT MULTI-MAX**

**Intended use – specification**

**Annex B1**

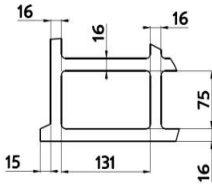
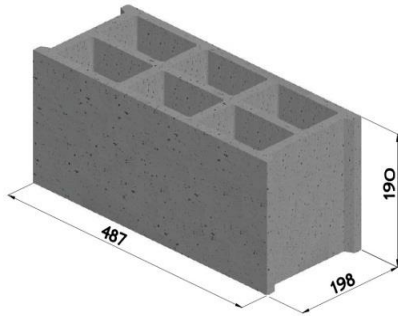

Brick #1: Concrete hollow block B40  
 NF P 14-301 & EN 771-3  
 $f_b \geq 6,0$  [N/mm<sup>2</sup>]  
 $\rho \geq 1$  kg/dm<sup>3</sup>

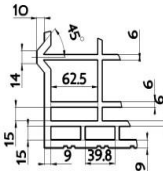
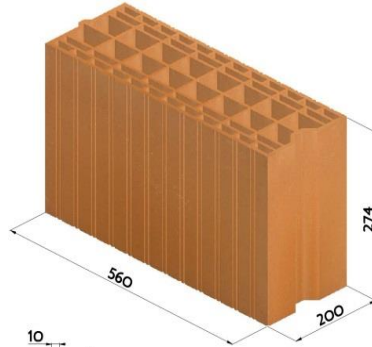

Brick #2: Clay masonry OPTIBRIC  
 PV 3+  
 NF EN 771-1 CN  
 $f_b \geq 9,0$  [N/mm<sup>2</sup>]  
 $\rho = 0,66$  kg/dm<sup>3</sup>

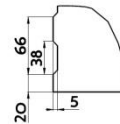
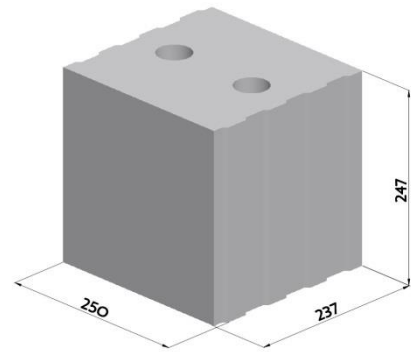

Brick #5: Calcium silicate masonry  
 KSL-R (P) 20-2,0-8 DF (240)  
 DIN EN 771-2  
 $f_b \geq 20,0$  [N/mm<sup>2</sup>]  
 $\rho = 2$  kg/dm<sup>3</sup>

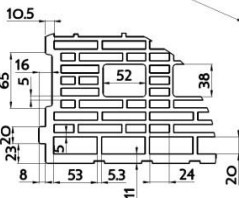
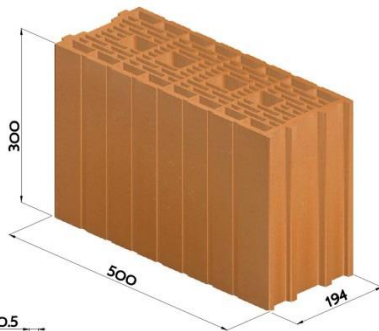

Brick #3: Clay masonry  
 POROTHERM GF R20 Th+  
 NF EN 771-1 CN  
 $f_b \geq 10,0$  [N/mm<sup>2</sup>]  
 $\rho = 0,67$  kg/dm<sup>3</sup>

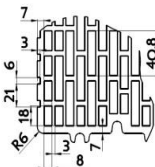
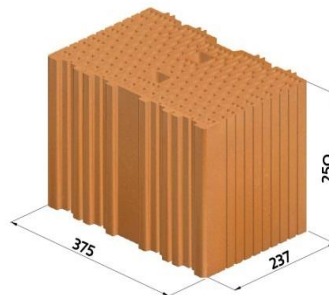

Brick #4: Clay masonry  
 POROTHERM R37  
 NF EN 771-1 CN  
 $f_b \geq 8,0$  [N/mm<sup>2</sup>]  
 $\rho = 0,79$  kg/dm<sup>3</sup>

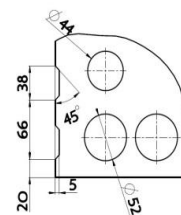
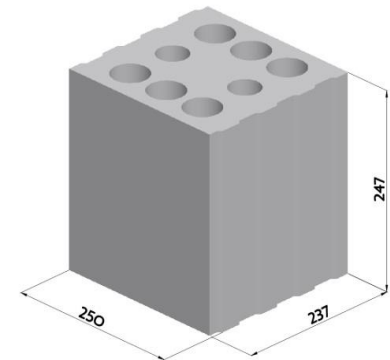











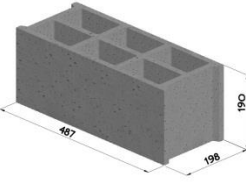



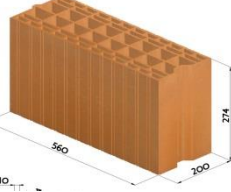



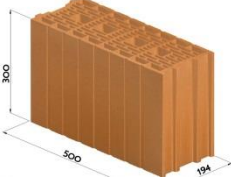

Brick #6: Calcium silicate masonry  
 KSL-R (P) 12-1,6-8 DF (240)  
 DIN EN 771-2  
 $f_b \geq 12,0$  [N/mm<sup>2</sup>]  
 $\rho = 1,6$  kg/dm<sup>3</sup>

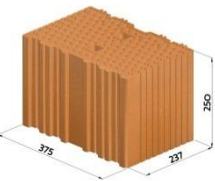
**SPIT MULTI-MAX**

**Types of bricks and dimensions**

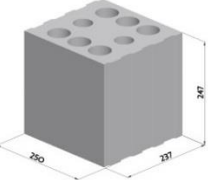
**Annex B2**

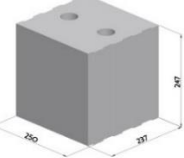

<b>Brick n°1</b> 		M8- M10	
		M8- M10	$T_{inst} = 2.0 \text{ N.m}$
		M12	
<b>Brick n°2</b> 		M8- M10	
		M8- M10	$T_{inst} = 2.0 \text{ N.m}$
		M12	
<b>Brick n°3</b> 		M8- M10	
		M8- M10	$T_{inst} = 3.0 \text{ N.m}$
		M12	
<b>Brick n°4</b> 		M8- M10	
		M8- M10	$T_{inst} = 3.0 \text{ N.m}$
		M12	
<b>Brick n°6</b> 		M8- M10	
		M8- M10	$T_{inst} = 3.0 \text{ N.m}$
		M12	
<b>Brick n°5</b> 	-	M8- M10- M12	$T_{inst} = 3.0 \text{ N.m}$
<b>SPIT MULTI-MAX</b>		<b>Annex B3</b>	
<b>Allocation of anchors, sleeves and bricks</b>			

**Table B2: Installation parameters**

Sleeve			-			iD-ALL		Perforated 15x130		Sleeve 20x85
Threaded rod			M8	M10	M12	M8	M10	M8	M10	M12
Drill hole diameter	d <sub>0</sub>	[mm]	10	12	14	16	16	15	15	20
Depth of drilled hole	h <sub>0</sub>	[mm]	80	80	80	70	70	135	135	90
Overall embedment depth	h <sub>ef</sub>	[mm]	80	80	80	70	70	135	135	90
Brush diameter	-	[mm]	11	13	15	-	-	-	-	-
Torque moment	T <sub>inst</sub>	[Nm]	See annex B3							

**Steel brush and installation procedure clean for the solid masonry**

**Nota:** For the hollow masonry the cleaning of hole is not necessary.



**Table B3 : Cleaning method for the solid masonry**

	Standard cleaning
Nominal diameter	All diameters
Cleaning method	4 blows+ 4 brushing operation + 4 blows <b>Blowing operation:</b> using a hand pump, blow 4 times. <b>Brushing operation:</b> using the relevant brush, starting from the top of the hole, move downward to the bottom of the hole then move upward to the top of the hole.

**Table B4: Minimum curing time**

Temperature in the concrete member	Working time	Minimum curing time in wet concrete
≥ + 0 °C	18 min	180 min
≥ + 5 °C	12 min	90 min
≥ + 10 °C	6 min	60 min
≥ + 20 °C	4 min	45 min
≥ + 30 °C	2 min	35 min

**SPIT MULTI-MAX**

**Installation instruction**

**Annex B4**

### Instruction For Use in solid masonry

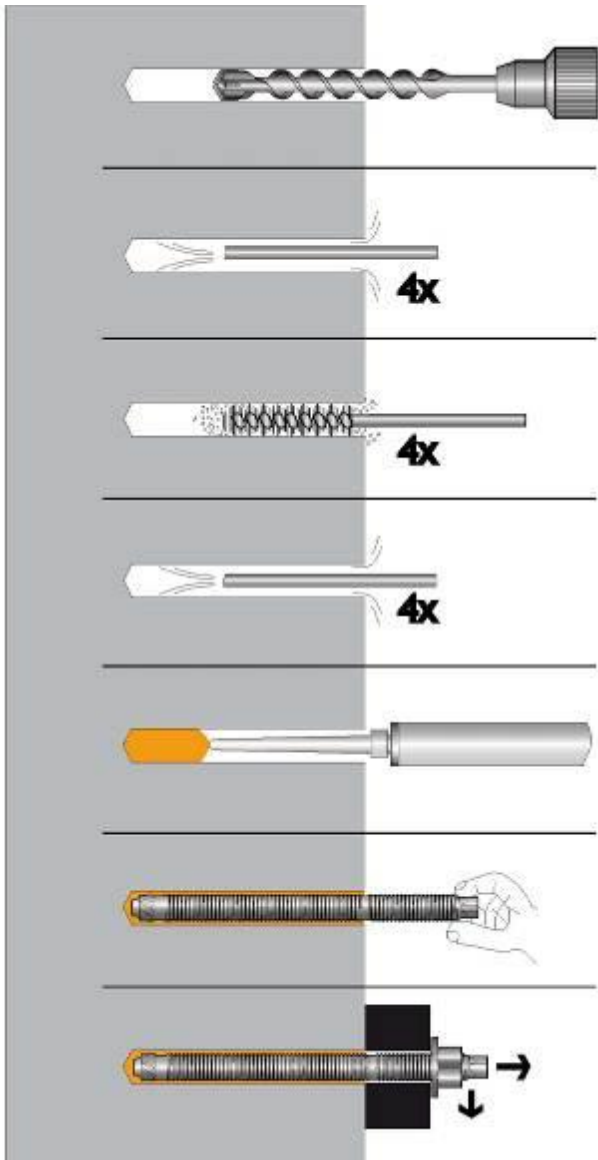

Drill hole of diameter ( $d_0$ ) and depth ( $h_0$ ) with a hammer drill set in rotation-hammer mode using an appropriately carbide drill bit.

4 strokes with SPIT blow-out pump from the back of the hole until return air stream is free of noticeable dust.

4 times with the specified brush size (brush diameter  $\geq$  borehole diameter  $d_0$ ) by inserting the SPIT steel wire brush to the back of the hole with a twisting motion and removing.

4 strokes with SPIT blow-out pump from the back of the hole until return air stream is free of noticeable dust.

Screw the mixing nozzle onto the cartridge and dispense the first part to waste until an even colour is achieved for each new cartridge or mixing nozzle. Use tube extensions for holes deeper than 250 mm. Starting from the bottom of the hole fill uniformly. In order to avoid air pocket, withdraw slowly the mixing nozzle while injecting the resin. Fill the hole until 1/2 full.

Insert the rod or rebar, slowly and with a slight twisting motion in respect of the gel time indicated in table 4. Remove excess resin from around the mouth of the hole before it sets. Control the embedment depth

Do not disturb anchor between specified cure time (acc. to table 4)

Attach the fixture and tight the nut at the specified torque

SPIT MULTI-MAX

Installation instruction in solid masonry

Annex B5

**Instruction for: Installation in hollow masonry**

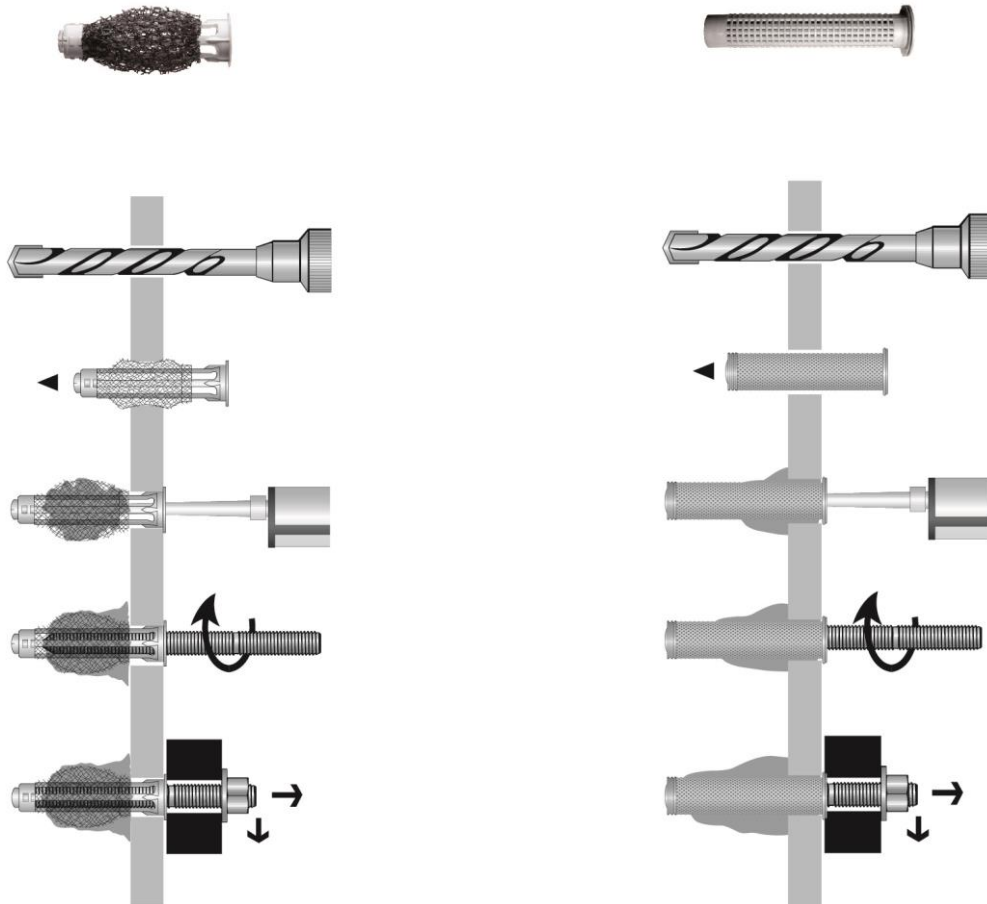

- The substrate should be perforated:
  - using rotation/percussion for bricks 1, 5 and 6,
  - using rotation only for bricks 2, 3 and 4.
- Manually position the iD-ALL system in the hole until the flange presses against the exterior wall of the masonry.
- Close the centering plug.
- After inserting the iD-ALL nozzle onto the cartridge, push the nozzle all the way in and inject the resin by pressing the gun six times.
- Using rotation, insert the threaded stud all the way in.
- After the resin hardens, install the item being mounted and tighten to the recommended torque.

- The substrate should be perforated:
  - using rotation/percussion for bricks 1, 5 and 6,
  - using rotation only for bricks 2, 3 and 4.
- Manually position the sieve sleeve in the hole until the flange presses against the exterior wall of the masonry.
- Close the centering plug.
- After inserting the nozzle onto the cartridge, push the nozzle all the way in and inject the resin by pressing the gun four times, then move the nozzle backwards and press four more times.
- Using rotation, insert the threaded stud all the way in.
- After the resin hardens, install the item being mounted and tighten to the recommended torque.

SPIT MULTI-MAX

Installation instruction in hollow masonry

Annex B6

**Table C1 : Characteristic values for tension and shear load**

Brick n°	Comp strength [N/mm <sup>2</sup> ]	sleeve	Anchor size	Effective embedment depth h <sub>ef</sub> [mm]	Characteristic resistance	
					N <sub>Rk</sub> <sup>1)</sup>	V <sub>Rk</sub> <sup>2) 3)</sup>
					[kN]	[kN]
1	6,0	iD-ALL	M8	70	2.0	2.5
			M10	70	2.0	2.5
		15x130	M8	135	1.5	3.0
			M10	135	1.5	3.0
		20x85	M12	90	1.5	2.0
2	9,0	iD-ALL	M8	70	1.5	1.5
			M10	70	1.5	1.5
		15x130	M8	135	1.5	1.5
			M10	135	1.5	1.5
		20x85	M12	90	2.5	3.5
3	10,0	iD-ALL	M8	70	0.9	4.0
			M10	70	0.9	4.0
		15x130	M8	135	1.2	3.5
			M10	135	1.2	3.5
		20x85	M12	90	2.5	3.0
4	8,0	iD-ALL	M8	70	1.2	0.9
			M10	70	1.2	0.9
		15x130	M8	135	2.0	1.5
			M10	135	2.0	1.5
		20x85	M12	90	0.9	4.0
5	20,0	-	M8	80	12.0	9.5
		-	M10	80	12.0	9.0
		-	M12	80	12.0	12.0
6	12,0	iD-ALL	M8	70	1.5	9.0
			M10	70	1.5	11.0
		15x130	M8	135	3.0	9.0
			M10	135	3.0	12.0
		20x85	M12	90	3.5	10.0
Partial safety factor γ <sub>M</sub>					2.5 <sup>4)</sup>	

1) For design according to TR54: N<sub>Rk</sub> = N<sub>Rk,p</sub> = N<sub>Rk,b</sub> = N<sub>Rk,pb</sub> = N<sub>Rk,s</sub>

2) Failure of the metal part and local brick failure: design according to TR54: V<sub>Rk</sub> = V<sub>Rk,b</sub> = V<sub>Rk,s</sub>

3) Brick edge failure: V<sub>Rk,c</sub> according to TR54

4) In absence of national regulations

**SPIT MULTI-MAX**

**Annex C1**

**Characteristic values for tension and shear load**

**Table C2 : Characteristic bending moment**

				M8	M10	M12
Characteristic bending moment	$M_{Rk,s}$	Property class	5.8 [N.m]	18.7	37.4	65.5
			8.8 [N.m]	30.0	59.8	104.8
			A4-70 [N.m]	26.2	52.3	91.7
Partial safety factor	$\gamma_{Ms,v}^{1)}$	Property class	5.8 [-]	1.25		
			8.8 [-]	1.25		
			A4-70 [-]	1.56		

1) In absence of national regulations

**Table C3 : Displacement under tension and shear load**

Brick N°	sleeve	Anchor size	Tension			Shear		
			Load F [kN]	Displacement		Load F [kN]	Displacement	
				$\delta_{N0}$ [mm]	$\delta_{N\infty}$ [mm]		$\delta_{v0}$ [mm]	$\delta_{v\infty}$ [mm]
1	iD-ALL	M8	$\frac{N_{Rk}}{1,4 \times \gamma_M}$	0.3	0.6	$\frac{V_{Rk}}{1,4 \times \gamma_M}$	1.1	2.3
		M10		0.3	0.6		1.1	2.3
	15x130	M8		0.2	0.4		4.7	9.4
		M10		0.2	0.4		4.7	9.4
	20x85	M12		0.2	0.5		1.2	2.4
	2	iD-ALL		M8	0.1		0.2	1.0
M10				0.1	0.2		1.0	2.1
15x130		M8		0.1	0.2		1.3	2.7
		M10		0.1	0.2		1.3	2.7
20x85		M12		0.5	1.0		7.2	14.3
3		iD-ALL		M8	0.1		0.2	2.4
	M10			0.1	0.2		2.4	4.8
	15x130	M8	0.2	0.3	2.6	5.1		
		M10	0.2	0.3	2.6	5.1		
	20x85	M12	0.2	0.4	4.9	9.9		
	4	iD-ALL	M8	0.7	1.4	0.5	0.9	
M10			0.7	1.4	0.5	0.9		
15x130		M8	0.2	0.5	2.3	4.7		
		M10	0.2	0.5	2.3	4.7		
20x85		M12	0.1	0.2	2.1	4.2		
5		-	M8	0.2	0.5	0.8	1.6	
	-	M10	0.4	0.8	0.5	1.0		
	-	M12	0.2	0.5	1.3	2.6		
6	iD-ALL	M8	0.2	0.3	2.5	4.9		
		M10	0.2	0.3	2.5	4.9		
	15x130	M8	0.3	0.5	1.8	3.5		
		M10	0.3	0.5	1.8	3.5		
	20x85	M12	0.1	0.2	0.5	1.1		

SPIT MULTI-MAX

Characteristic bending moments  
Displacements

Annex C2

**Table C4 :  $\beta$  factor for tests to be carried out on construction works**

Bricks	Installation and use	Sleeves	sizes	$\beta$ factor
All types	w/w	iD-ALL	M8 & M10	0.826
		15 x 130	M8 & M10	0.826
		20 x 85	M12	0.776

**Table C5 : Edge distances and spacing**

Brick n°	Anchor size								
	M8			M10			M12		
	$C_{min}$ [mm]	$S_{min,\perp}$ [mm]	$S_{min,\parallel}$ [mm]	$C_{min}$ [mm]	$S_{min,\perp}$ [mm]	$S_{min,\parallel}$ [mm]	$C_{min}$ [mm]	$S_{min,\perp}$ [mm]	$S_{min,\parallel}$ [mm]
1	100	190	487	100	190	487	120	190	487
2	100	274	560	100	274	560	120	274	560
3	100	300	500	100	300	500	120	300	500
4	100	250	237	100	250	237	120	250	237
5	120	240	240	120	240	240	120	240	240
6	100	247	250	100	247	250	120	247	250

Nota:  $S_{min} = S_{cr}$  and  $C_{min} = C_{cr}$

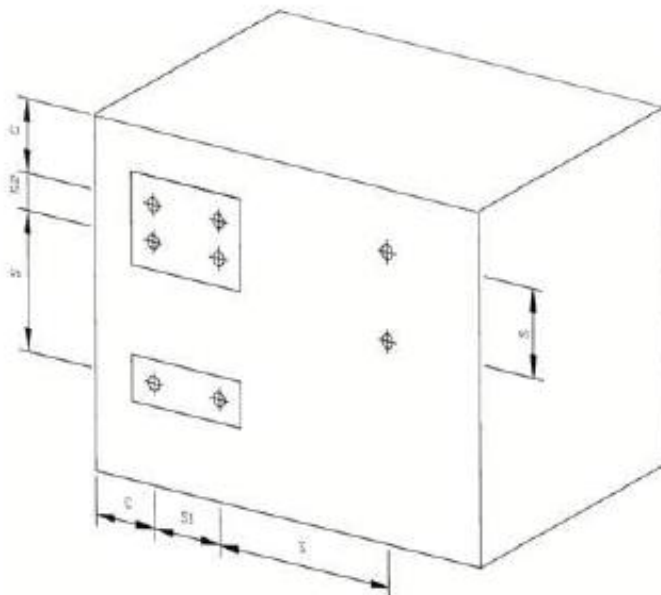

SPIT MULTI-MAX

$\beta$  factor  
 Edge distances and spacing

Annex C3